

1- Marque los agujeros. **2-** Realice las perforaciones. **3-** Introduzca los chazos.

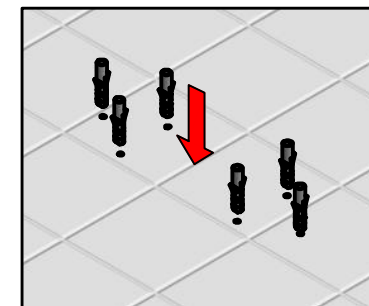
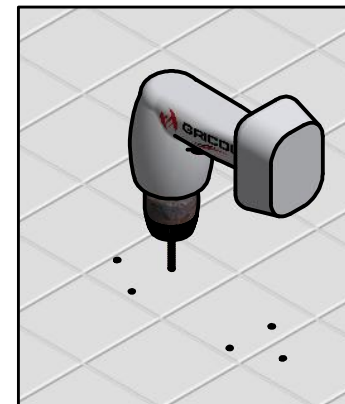
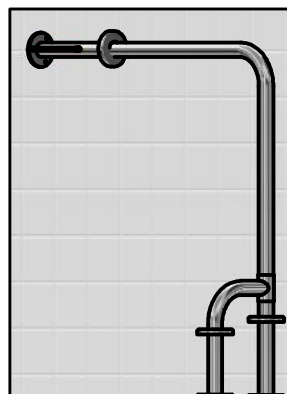

Barra

Tornillo
Escudo

Chazo

4- Monte la barra y ajuste con los tornillos.

5- Deslice los escudos.

Ensamble finalizado

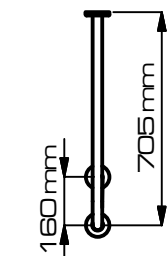
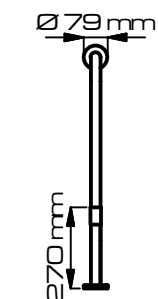
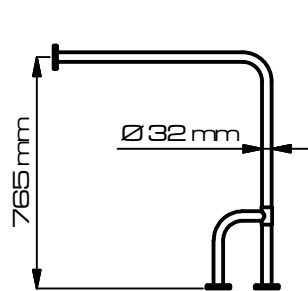
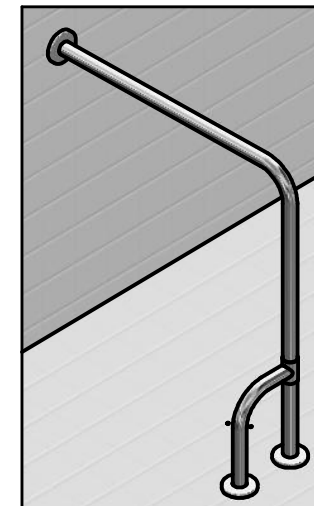
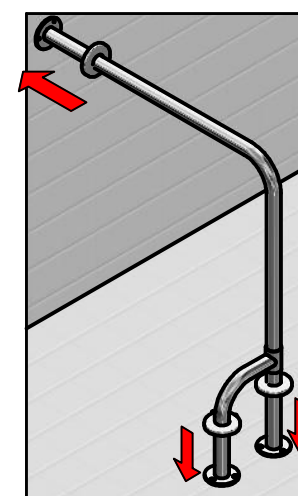
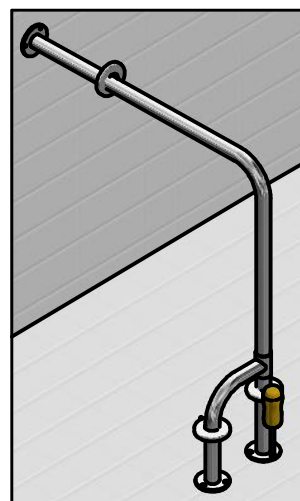

Vista lateral derecha

Vista frontal

Vista superior