

**1** - La instalación de la mesa debe ser a una altura de: **(783 - 792 mm)**

**2** - Marque los agujeros.

**3** - Realice las perforaciones.

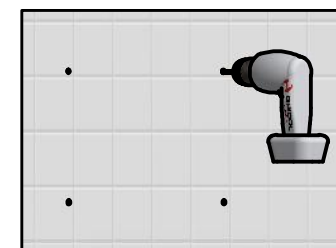
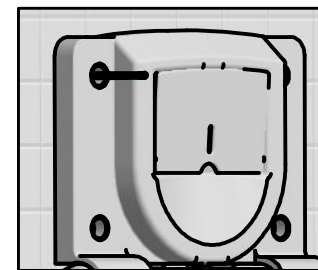
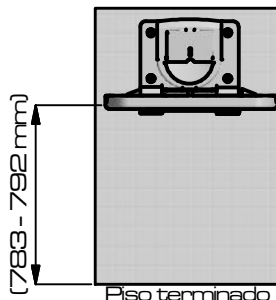

**4** - Introduzca los chazos.

**5** - Ajuste los tornillos.

**6** - Ajuste las tapas.

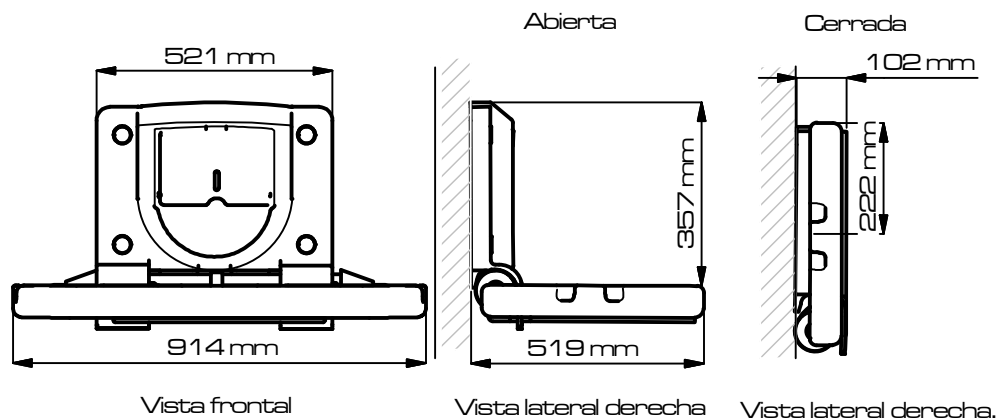
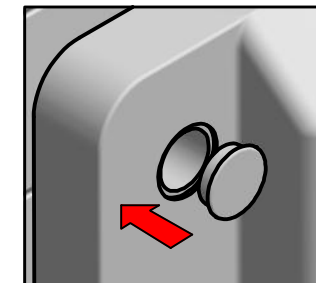
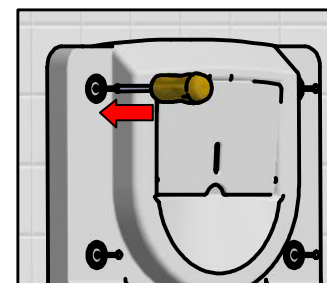
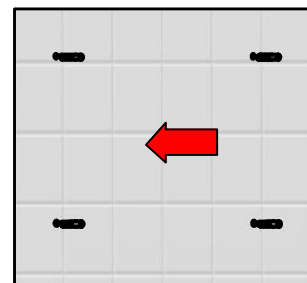

**ENSAMBLE FINALIZADO**

